

# OPTIMA 1438m

## User manual



## **FCC STATEMENT**

This device complies with Part 15 of the FCC Rules. Operation is subject to the following two conditions:

- (1) This device may not cause harmful interference, and
- (2) This device must accept any interference received, including interference that may cause undesired operation.

**Note:**

This equipment has been tested and found to comply with the limits for Class B digital devices, pursuant to Part 15 of the FCC rules. These limits are designed to provide reasonable protection against harmful interference in a residential installation. This equipment generates, uses and can radiate radio frequency energy and, if not installed and used in accordance with the instructions, may cause harmful interference to radio communications. However, there is no guarantee that interference will not occur in a particular installation. If this equipment does cause harmful interference to radio or television reception, which can be determined by turning the equipment off and on, the user is encouraged to try to correct the interference by one or more of the following measures:

- Reorient or relocate the receiving antenna.
- Increase the separation between the equipment and receiver.
- Connect the equipment into an outlet on a circuit different from that to which the receiver is connected.
- Consult the dealer or an experienced radio/TV technician for help.

Use of shielded cable is required to comply with Class B limits in Subpart B of Part 15 of the FCC rules.

Do not make any changes or modifications to the equipment unless otherwise specified in the manual. If such changes or modifications should be made, it may be necessary to stop operation of the equipment.

**Notice**

If static electricity or electromagnetism causes data transfer to discontinue midway (fail), restart the application or disconnect and connect the communication cable (USB, etc.) again.

## **READ THIS FIRST**

### **Trademark Information**

- Microsoft® and Windows® are U.S. registered trademarks of Microsoft Corporation.
- Pentium® is a registered trademark of Intel Corporation.
- Macintosh is a trademark of Apple Inc.
- SD™ is a trademark.
- SDHC™ is a trademark.
- Other names and products may be trademarks or registered trademarks of their respective owners.

### **Product Information**

- Product design and specifications are subject to change without notice. This includes primary product specifications, software, software drivers, and user's manual. This User Manual is a general reference guide for the product.
- The product and accessories that come with your camera may be different from those described in this manual. This is due to the fact that different retailers often specify slightly different product inclusions and accessories to suit their market requirements, customer demographics, and geographical preferences. Products very often vary between retailers especially with accessories such as batteries, chargers, AC adapters, memory cards, cables, pouches, and language support. Occasionally a retailer will specify a unique product color, appearance, and internal memory capacity. Contact your dealer for precise product definition and included accessories.
- The illustrations in this manual are for the purpose of explanation and may differ from the actual design of your camera.
- The manufacturer assumes no liability for any errors or discrepancies in this user manual.

## SAFETY INSTRUCTIONS

Read and understand all **Warnings** and **Cautions** before using this product.

### Warnings

**If foreign objects or water have entered the camera, turn the power off and remove the battery.**

Continued use might cause fire or electric shock. Consult the store of purchase.



**If the camera has fallen or its case has been damaged, turn the power off and remove the battery.**

Continued use might cause fire or electric shock. Consult the store of purchase.



**Do not disassemble, change or repair the camera.**

This might cause fire or electric shock. For repair or internal inspection, ask the store of purchase.



**Do not use the camera in areas near water.**

This might cause fire or electric shock. Take special care in rain, snow, on the beach, or near the shore.



**Do not place the camera on inclined or unstable surfaces.**

This might cause the camera to fall or topple over, causing damage.



**Keep the battery out of the reach of children.**

Swallowing the battery might cause poisoning. If the battery is accidentally swallowed, immediately consult a physician.



**Do not use the camera while you are walking, driving or riding a motorcycle.**

This might cause you to fall over or result in a traffic accident.



**Only use a battery with intact external seals.**

Do not use a battery whose seals have been damaged or removed. This may cause leakage, explosion, or injury.



## Cautions

**Insert the battery paying careful attention to the polarity (+ or –) of the terminals.**

Inserting the battery with its polarities inverted might cause fire and injury, or damage to the surrounding areas due to the battery rupturing or leaking.



**Do not fire the flash close to anyone's eyes.**

This might cause damage to the person's eyesight.



**Do not subject the LCD monitor to impact.**

This might damage the glass on the screen or cause the internal fluid to leak. If the internal fluid enters your eyes or comes into contact with your body or clothes, rinse with fresh water. If the internal fluid has entered your eyes, consult a physician immediately.



**A camera is a precision instrument. Do not drop it, strike it or use excessive force when handling the camera.**

This might cause damage to the camera.



**Do not use the camera in humid, steamy, smoky, or dusty places.**

This might cause fire or electric shock.



**Do not remove the battery immediately after long period of continuous use.**

The battery becomes hot during use. Touching a hot battery might cause burns.



**Do not cover the camera or wrap it in cloths or blankets.**

This might cause heat to build up and deform the case, resulting in fire. Use the camera in a well-ventilated location.



**Do not leave the camera in places where the temperature may rise significantly, such as inside a car.**

This might adversely affect the case or the parts inside, resulting in fire.



**Before you move the camera, disconnect cords and cables.**

Failure to do this might damage cords and cables, resulting in fire and electric shock.



## **Notes on Battery Usage**

When you use the battery, carefully read and strictly observe the **Safety Instructions** and the notes described below:

- Use only the specified battery (3.7V).
- Avoid extremely cold environments as low temperatures can shorten the battery life and reduce camera performance.
- When you are using a new rechargeable battery or a rechargeable battery that has not been used for an extended period of time (a battery that has passed its expiry date is an exception), it may affect the number of images that can be captured. Therefore, to maximize its performance and lifetime, we recommend that you fully charge the battery and discharge it for at least one complete cycle before use.
- The battery may feel warm after a long period of continuous use of the camera or the flash. This is normal and not a malfunction.
- The camera may feel warm after a long period of continuous use. This is normal and not a malfunction.
- If the battery is not to be used for a long period of time, remove it from the camera to prevent leakage or corrosion and store it after no battery power is left. Stored for a long time in a fully charged condition, its performance may be impaired.
- Always keep the battery terminals clean.
- There is a risk of explosion if the battery is replaced by an incorrect type.
- Dispose of the used battery in accordance with recycling instructions.
- Charge the rechargeable battery fully before using for the first time.
- To prevent short-circuiting or fire, keep the battery away from other metal objects when carrying or storing.



This symbol mark [crossed-out bin] indicates separate collection of waste batteries in the EU countries. The batteries provided with this product should not be treated as household waste. Please use the return and collection systems available in your country for the disposal of the waste batteries.

If a chemical symbol is printed beneath the symbol mark, this chemical symbol means that the batteries contain a heavy metal at a certain concentration. Meanings as follows:  
Hg: mercury, Cd: cadmium, Pb: lead.

# CONTENTS

- 7 INTRODUCTION**
  - 7 Overview
  - 7 Package Contents
- 8 GETTING TO KNOW YOUR CAMERA**
  - 8 Front View
  - 9 Rear View
  - 10 LCD Monitor Display
- 12 GETTING STARTED**
  - 12 Preparation
  - 13 Charging the Battery
  - 14 Initial Settings
- 16 CAPTURE MODE**
  - 16 Capturing Images
  - 17 Setting the Scene Mode
  - 17 Setting the Panorama Mode
  - 18 Taking Images When the Smile Feature Is On
  - 19 Recording Shots into Multiple Image Layout
  - 19 Recording Shots using Face Detection Technology
- 20 VIDEO MODE**
  - 20 Recording Video Clips
  - 20 Playing Back Video Clips
- 21 PLAYBACK MODE**
  - 21 Playing Back Still Images
  - 22 Playback Display
  - 22 Removing Red-eye
  - 23 Attaching Voice Memos
  - 24 Protecting Images
  - 25 DPOF Settings
  - 26 Erasing Images
- 27 MENU OPTIONS**
  - 27 Capture Menu
  - 30 Video Menu
  - 31 Playback Menu
  - 33 Setup Menu
- 35 TRANSFERRING FILES TO YOUR COMPUTER**
  - 35 Downloading Your Files
- 36 USING THE CAMERA AS A PC CAMERA**
- 37 EDITING SOFTWARE INSTALLATION**
- 38 SPECIFICATIONS**
- 39 APPENDIX**
  - 39 Possible Number of Shots
  - 40 Troubleshooting
  - 41 Connecting to a PictBridge Compliant Printer
  - 43 Customer Care

# **INTRODUCTION**

## **Overview**

Thank you for purchasing this AgfaPhoto digital camera. Please read these operating instructions carefully in order to use the digital camera correctly. Keep the instructions in a safe place after reading so that you can refer to them later.

## **Package Contents**

Carefully unpack your camera and ensure that you have the following items:

### **Package Contents:**

- OPTIMA 1438m
- User's manual
- Software CD-ROM
- USB cable
- AV cable
- Camera strap
- Camera pouch
- Rechargeable lithium-ion battery
- Battery charger
- AC adapter for battery charger



## GETTING TO KNOW YOUR CAMERA

### Front View

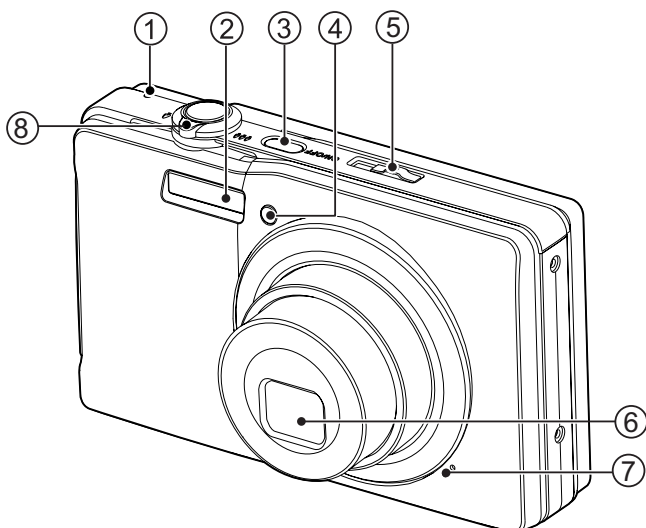

- 1. Status LED
- 2. Flash
- 3. **ON/OFF** Power button
- 4. Self-timer LED
- 5. Mode switch
- 6. Lens
- 7. Microphone
- 8. Zoom lever

## Rear View

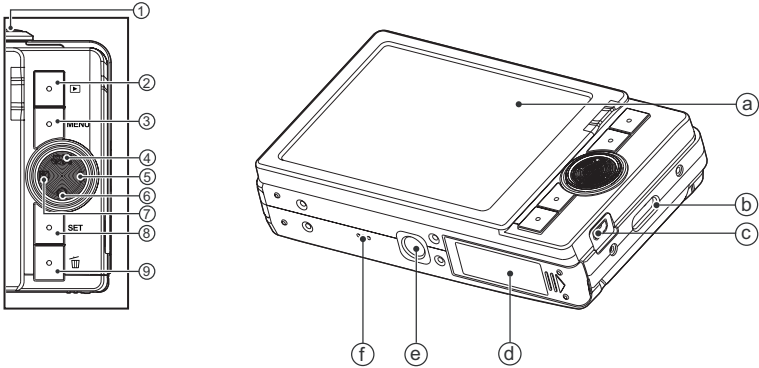

- a. LCD monitor
- b. Strap holder
- c. USB or AV OUT terminal
- d. Battery / Memory card cover
- e. Tripod socket
- f. Speaker

Item	Function		
	Capture Mode	Video Mode	Playback Mode
1.	Shutter button	Record button	Voice memo rec.
2.	Playback	Playback	Playback
3.	Menu	Menu	Menu
4.	Focus Auto>  >  >	Focus Auto>  >	Go 10 images forwards
5.	Flash Auto>  >  >  >	--	Next Image
6.	Self-timer Off>2s>10s>10+2s	Self-timer Off>2s>10s	Go 10 images backwards
7.	Compensation >	--	Previous Image
8.	Set	Set	Set
9.	Delete	Delete	Delete

## LCD Monitor Display

### Capture mode

1. Zoom status
2. Battery condition
  - [Full] Full battery power
  - [Medium] Medium battery power
  - [Low] Low battery power
  - [Empty] No battery power
3. Flash mode
  - [Blank] Auto Flash
  - [Flash] Forced Flash
  - [Off] Flash Off
  - [Red-eye] Red-eye Reduction
  - [Slow Sync] Slow Sync
  - [Pre-flash] Pre-flash
4. Storage media
  - [Internal] Internal memory (no card)
  - [SD/SDHC] SD/SDHC memory card
5. [Histogram] Histogram
6. Main focus area
7. Image quality
  - [Fine] Fine
  - [Standard] Standard
  - [Economy] Economy
8. Image size resolution
  - [3648x2736] 3648 x 2736
  - [2816x2112] 2816 x 2112
  - [2272x1704] 2272 x 1704
  - [1600x1200] 1600 x 1200
  - [VGA] 640 x 480
9. Available number of shots
10. ISO
  - [Blank] Auto
  - [64] ISO 64
  - [100] ISO 100
  - [200] ISO 200
  - [400] ISO 400
  - [800] ISO 800
  - [1600] ISO 1600
11. Self-timer icon
  - [2s] 2 sec.
  - [10s] 10 sec.
  - [10+2s] 10+2 sec.
12. Date and time
13. [Exposure compensation] Exposure compensation  
 [Backlight correction] Backlight correction  
 (Adjust exposure value with the ◀ / ▶ buttons)
14. Capture mode icon
  - [Blank] Single
  - [Continuous] Continuous
  - [AEB] AEB
  - [Album Shot] Album Shot

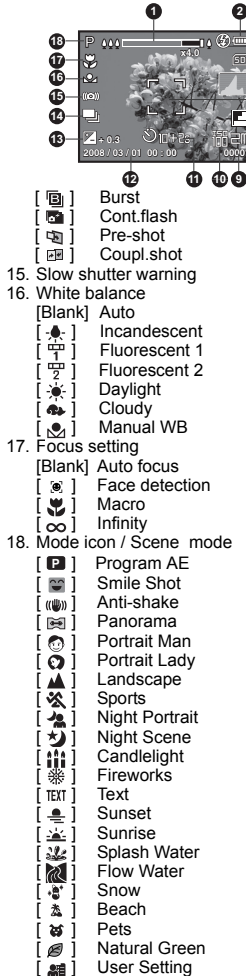

**Video mode**

1. Zoom status
2. Flash mode
3. Battery condition
4. Storage media
5. Main focus area
6. Video quality
7. Video resolution
8. Available recording time/Elapsed time
9. Self-timer icon
10. Date and time
11. Focus setting
12. Mode icon

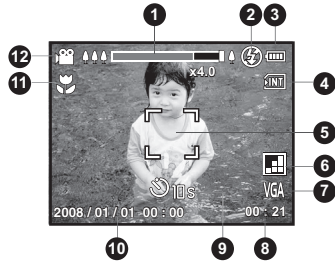

**Playback mode - Still image playback**

1. Voice memo
2. Battery condition
3. Storage media
4. Histogram
5. Image quality
6. ISO
7. Image size resolution
8. File number
9. Folder number
10. Date and time
11. Exposure value
12. Aperture value
13. Shutter speed value
14. DPOF icon
15. Protect icon
16. Mode icon



**Playback mode - Video playback**

1. Video status bar
2. Elapsed time
3. File number
4. Folder number
5. Sound off icon (When the ▲ button is pressed during video playback)
6. Play mode
7. Mode icon
8. Total recorded time



# GETTING STARTED

## Preparation

1. Attach the camera strap.

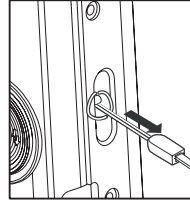

2. Open the battery/memory card cover.
3. Insert the supplied battery with correct orientation as shown. (label side to the back)

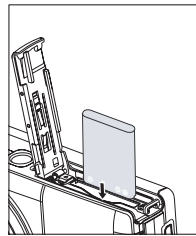

4. Insert an SD/SDHC memory card (Optional).
  - The camera has 32MB internal memory (27MB available for image storage), but you can load an SD/SDHC memory card to expand the camera's memory capacity.
  - Be sure to format the memory card with this camera before its initial usage.
5. Close the battery/memory card cover and make sure it is locked securely.

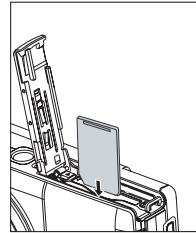

- To prevent valuable data from being accidentally erased from an SD/SDHC memory card, you can slide the write protect tab (on the side of the SD/SDHC memory card) to "LOCK".
- To save, edit, or erase data on an SD/SDHC memory card, you must unlock the card.
- To prevent damaging an SD/SDHC memory card, be sure to turn off the power when inserting or removing the SD/SDHC memory card. If inserting or removing the SD/SDHC memory card with the power on, the camera will automatically turn off.

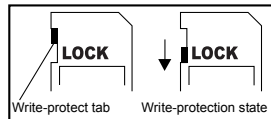

## **Charging the Battery**

Charge the battery fully with the supplied battery charger before use.

1. Insert the battery into the battery charger.
2. Connect the power cord to the charger and insert the plug into a wall outlet.

- The status LED on the charger lights red when charging has started and lights green when charging is completed. The LED also lights green if no battery is inserted into the charger.
- Charging time varies according to the ambient temperature and the status of the battery.
- Remove the battery after charging is completed.

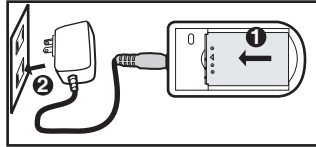

- The battery may feel warm after it has been charged or immediately after being used. This is normal and not a malfunction.
- When using the camera in cold areas, keep the camera and battery warm by holding them inside your outer clothes.

## Initial Settings

### Setting the Date and Time

The date/time needs to be set if and when:

- The camera is turned on for the first time.
- The camera is turned on after leaving the camera without the battery for an extended period of time.





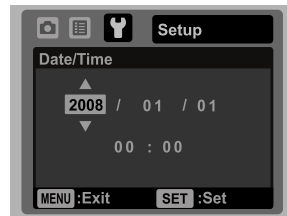



When the date and time information is not displayed on the LCD monitor, follow these steps to set the correct date and time.

1. Slide the mode switch to [CAM] or [CAM]; or press the [CAM] button.
2. Press the MENU button.
3. Select [Setup] with the ► button.
4. Select [Date/Time] with the ▲ / ▼ buttons, and press the SET button.
5. Select the date format with the ▲ / ▼ buttons, and press the SET button.
  - Select the item field with the ◀ / ▶ buttons and adjust the value for the date and time with the ▲ / ▼ buttons.
  - The time is displayed in 24-hour format.
  - After confirming all settings are correct, press the SET button.
6. To exit from the [Setup] menu, press the MENU button.



## Choosing the Language









Specify in which language menus and messages are to be displayed on the LCD monitor.

1. Slide the mode switch to [  ] or [  ]; or press the  button.
2. Press the MENU button.
3. Select [Setup] menu with the  button.
4. Select [Language] with the  /  buttons and press the SET button.
5. Select the displayed language with the  /  buttons and press the SET button.
  - The setting will be stored.



## Formatting the Memory Card or Internal Memory

This utility formats the internal memory (or memory card) and erases all stored images and data.

1. Slide the mode switch to [  ] or [  ]; or press the  button.
2. Press the MENU button.
3. Select [Setup] menu with the  button.
4. Select [Format] with the  /  buttons, then press the SET button.
5. Select [Execute] with the  /  buttons, and press the SET button.
  - To cancel formatting, select [Cancel] and press the SET button.

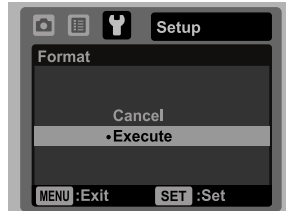





## CAPTURE MODE

### Capturing Images

Your camera is equipped with a 3.0" full color TFT LCD monitor to help you compose images, playback recorded images/video clips or adjust menu settings.

1. Press the **ON/OFF** button to turn the power on.
  - The status LED lights green and the camera is initiated.
2. Slide the mode switch to [  ].
3. Compose your image in the LCD monitor.
  - Slide the zoom lever to  side to zoom in on the subject, and enlarge the subject on the LCD monitor.
  - Slide the zoom lever to  side to zoom out on the subject, and provide a wider angle image.
4. Press the shutter button.
  - Pressing the shutter button down halfway automatically focuses and adjusts the exposure, and pressing the shutter button down fully captures the images.
  - The focus area frame turns green when the camera is in focus and the exposure is calculated.
  - When the focus or exposure is not suitable, the frame of the focus area turns red.

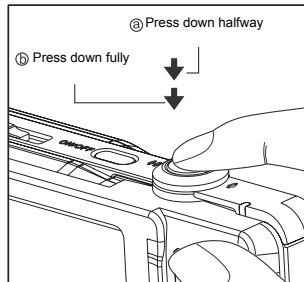

- If the camera stops responding when you press any of the camera buttons, press and hold (more than 2 seconds) the **ON/OFF** button to turn off the camera.

## Setting the Scene Mode

By simply selecting one of the available 21 scene modes, you can capture the image with the most appropriate settings.

1. Slide the mode switch to **[SCN]**.

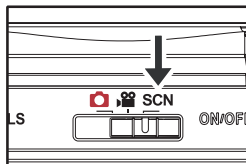

2. Select the desired scene mode with the ◀ / ▶ buttons, and press the SET button.
3. Compose the image and press the shutter button.



## Setting the Panorama Mode

This mode is designed to make it easier to take a series of shots then stitch them together with software to make a single image. You can capture a photographic subject that won't fit into a single frame, such as a landscape, and stitch it together later with a program like the Panorama Maker application.

1. Slide the mode switch to **[SCN]**.
2. Select [Panorama] with the ◀ / ▶ buttons, and press the SET button.
3. Select the photographic direction with the ◀ / ▶ buttons.
4. Shoot the first image.
  - The next image appears beside the previous image.
5. Orient the camera so that the second frame overlaps a small portion of the photographic subject of the first image and press the shutter button to capture the next image.
6. Follow the same steps to capture subsequent images in the sequence.
7. Finish the sequence by pressing the MENU button or switch to another mode after the last image has been recorded.

## Taking Images When the Smile Feature Is On

With the camera's new "smile detection" function, this camera detects smiles so you don't miss those special moments in life.

1. Slide the mode switch to **[SCN]**.
2. Select [Smile Shot] with the ◀ / ▶ buttons, and press the SET button.
3. Compose the image, and press the shutter button down fully.

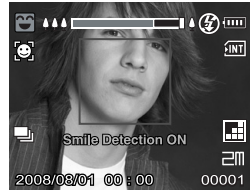

4. Once the camera detects a smile, it will automatically capture 3 images (by default, the flash mode setting is set to ☺).
  - If the flash mode setting is changed to ¼, the camera will only capture an image after it detects a smile.
  - When capturing group shots (if the number of people is more than 1), the camera will automatically capture the image(s) when it detects two smiles. The number of shots taken depends on the flash mode setting.
  - If the camera does not detect a smile within 5 seconds, the camera returns to preview display.
  - Press the shutter button once again to reactivate this function.

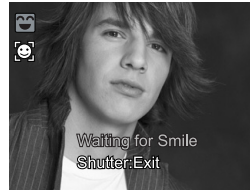

## Recording Shots into Multiple Image Layout



The Album Shot mode enables you to easily record images and combine three shots into a single image.

1. Slide the mode switch to [  ].
2. Press the MENU button, and select the [Function] menu with the ► button.
3. Select [Capture Md.] with the ▲ / ▼ buttons, and press the SET button.
4. Select [Album Shot] with the ▲ / ▼ buttons, and press the SET button.
5. Press the MENU button.
6. Press the shutter button to capture the first image.
7. Press the shutter button again to capture the second and third images.
  - Pressing the SET button during step 2 or 3 will delete the last captured image.
  - The camera returns to normal preview display by pressing the ▼ button. Press the ▼ button again to switch back to album shot preview display.
  - This shot can only be recorded if there are 3 shots recorded in each of the available frames.

## Recording Shots using Face Detection Technology

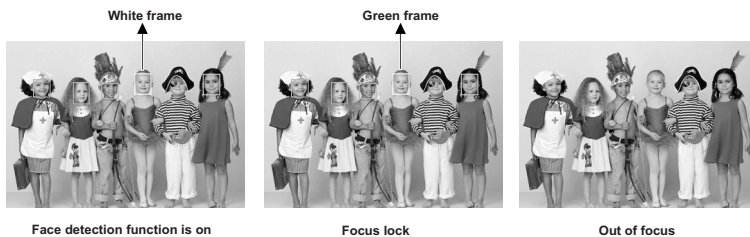
Face Detection Technology can identify and focus on the human faces in the image. This advanced function simultaneously detects up to 5 human faces regardless of their position in the scene.



1. Slide the mode switch to [  ].
2. Press the  button until the [  ] icon appears on the LCD monitor.
  - The white frame is identified as the “top priority” face (main focus frame), with gray ones around the other faces.
3. Press the shutter button halfway down to lock the focus.
  - The main focus frame simultaneously turns green.
  - If the “top priority” face is out of focus, all frames will disappear from the screen.
4. Press the shutter button down fully to capture your image.



- Subjects that are not suitable for this function:
  - a. A person wearing glasses, sunglasses, or a face covered with a hat or hair.
  - b. A person turning sideways.

## VIDEO MODE

### Recording Video Clips

This mode allows you to record video clips at a resolution of 320 x 240 / 640 x 480 pixels.

1. Slide the mode switch to [📹].
2. Compose the image.
3. Press the shutter button.
  - The recording of the video clip will start.
  - Pressing the shutter button one more time will end the recording of the video clip.
  - The recording time depends on the storage size and the subject of the image to be recorded.
  - The zoom function cannot be used during video recording.

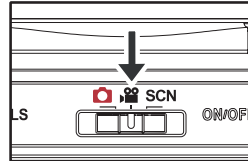

- When recording a video clip, the flash and "10+2 sec." self-timer function cannot be used.
- If the write speed of your SD/SDHC memory card is not fast enough for recording video clips in the currently selected quality, the video recording will stop. In this case, select a video quality lower than the current one.

### Playing Back Video Clips

You can play back recorded video clips on the camera. You can also play back sound if recorded with the video.

1. Press the [▶] button.
  - The last image appears on the screen.
2. Select the desired video clip with the ◀ / ▶ buttons.
3. Press the SET button.
  - Pressing the ▶ / ◀ buttons during playback allows fast forward play / fast reverse play.
  - To stop video playback, press the ▼ button.  
This stops playback and returns to the start of the video clip.
  - To pause video playback, press the SET button.  
This pauses video playback.  
To cancel pause, press the SET button again.









- Video clips cannot be displayed rotated or enlarged.
- Windows Media player or QuickTime Player is recommended to play back the video clip on your computer.
- QuickTime Player is a free media player available at [www.apple.com](http://www.apple.com) and compatible with Mac and Windows computers.
- For more information about the operation of the media player, refer to its respective help documentation.



## PLAYBACK MODE

### Playing Back Still Images

You can play back still images on the LCD monitor.

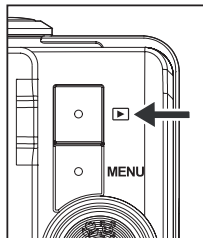







1. Press the  button.
  - The last image appears on the screen.
2. The images can be displayed in forward or reverse sequence with the  /  buttons.
  - To view the previous image, press the  button.
  - To view the next image, press the  button.
  - Slide the zoom lever to  side to enlarge the image.
  - To return to normal magnification, slide the zoom lever to  side.





- A  icon is displayed with the video data. Video clips cannot be rotated.
- A  icon is displayed with images which have an audio memo recorded.

## Playback Display

This function allows you to search quickly for the image that you want and playback images on the LCD monitor sequentially.









1. Press the  button.
2. Press the  button to display the next 10th image.
  - If the 1st image taken is displayed, press the  button to playback the 11th image taken. Press the  button again to playback the 21st image taken and so forth.
3. Press the  button to display the previous 10th image.
4. Press and hold the  /  buttons to display the previous or next images automatically in sequential order.
  - Release the  /  buttons if you wish to stop the automatic playback.



- If the total number of images is less than 10, pressing the  button jumps to the first image and pressing the  button jumps to the last image.
- Video clips will be displayed with an  icon.

## Removing Red-eye

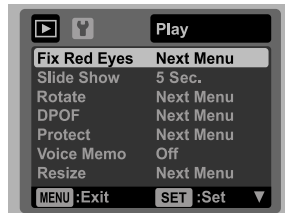

You can use this function to remove the red-eye effect after an image is taken.

1. Press the  button.
2. Select the image that you want to edit with the  /  buttons.
3. Press the MENU button.
4. Select [Fix Red Eyes] with the  /  buttons, and press the SET button.
5. Select [Execute] with the  /  buttons, and press the SET button.
6. View the changes on the corrected image.
7. To save your corrected image, select [Confirm] with the  /  buttons, and press the SET button.
  - When this process ends, this replaces the original image with the corrected image.



## Attaching Voice Memos

A maximum of 30 seconds of audio can be recorded as a memo for captured still images. The voice memo can be recorded only once.

1. Press the  button.
  - The last image appears on the screen.
2. Select the image to which you want to attach the voice memo with the ◀ / ▶ buttons.
3. Press the MENU button.
4. Select [Voice Memo] with the ▲ / ▼ buttons, and press the SET button.
5. Select [On] with the ▲ / ▼ buttons, and press the SET button.
6. Press the MENU button to exit from the menu.
7. Press the SET button.
  - [VOICE RECORDING] is displayed on the screen and recording starts.
8. To stop recording a voice memo as it is being recorded, press the SET button again.
  - [VOICE RECORD END] will be displayed and the recording will end. An  icon is displayed with images that have been recorded with a voice memo.

## Playing back voice memos

Pressing the SET button displays [VOICE PLAYBACK] and plays back the voice memo.













- 
- Voice memo is only available for still images.



## Protecting Images

Set the data to read-only to prevent images from being erased by mistake.







1. Press the  button.
2. Select the image that you want to protect with the  /  buttons.
3. Press the MENU button.
4. Select [Protect] with the  /  buttons, and press the SET button.
5. Select [Single] or [All] with the  /  buttons, and press the SET button.
6. Select [Set] with the  /  buttons, and press the SET button.
  - Protection is applied to the image and the camera returns to the playback mode.
  - The protect icon  is displayed with protected images.

When [All] has been selected,  is displayed with all the images.



## Canceling the Protection

To cancel protection for only one image, display the image on which you want to remove the image protection.





















1. Select [Protect] with the  /  buttons from the playback menu, and press the SET button.
2. Select [Single] or [All] with the  /  buttons, and press the SET button.
3. Select [Cancel Protect] with the  /  buttons, and press the SET button.
  - The removal of image protection is executed and the camera returns to the playback mode.



- Formatting an SD/SDHC memory card overrides protection, and erases all images regardless of their protected status.

## DPOF Settings

DPOF is the abbreviation for Digital Print Order Format, which allows you to embed printing information on your memory card. You can select the images to be printed and how many prints to make with the DPOF menu in the camera and insert the memory card to a card compatible printer. When the printer starts printing, it will read the embedded information on the memory card and print the specified images.

1. Press the  button.
2. Select the image that you want to set DPOF with the  /  buttons.
3. Press the MENU button.
4. Select [DPOF] with the  /  buttons, and press the SET button.
  - The DPOF setting screen is displayed.
5. Select [Single] or [All] with the  /  buttons, and press the SET button.
  - [Single]: Sets DPOF for each individual image.
  - [All]: Sets DPOF for all images at once.
6. Select [Print Num.] with the  /  buttons, and press the SET button.
  - This displays the number of prints setting screen.
7. Set the number of prints with the  /  buttons, and press the SET button.
  - You can set up to 9 prints for each image.
8. Select [Date Print] with the  /  buttons, and press the SET button.
  - The date setting screen appears.
9. Select date to [On] or [Off] with the  /  buttons, and press the SET button.
  - [On]: The date of the image will also be printed.
  - [Off]: The date of the image will not be printed.
10. Select [Print] with the  /  buttons, and press the SET button.
11. Select [Execute] with the  /  buttons, and press the SET button.
  - This creates a file containing the DPOF information, and when the operation is finished, the screen returns to the playback mode.
  - The DPOF icon  is displayed on each image that has DPOF settings set up.

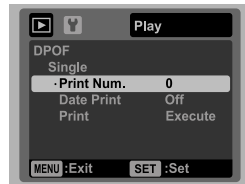



- The date that is printed on the image is the date set on the camera. To print the correct date on the image, set the date on the camera before you capture the image. Refer to the section in this manual titled "Setting the Date and Time" for further details.

## Erasing Images



### Erasing in Photography Mode (Quick Delete Function)

The quick delete function enables you to delete the last captured image during capture.

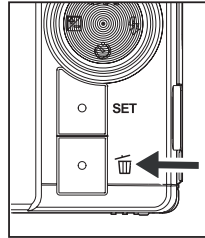
1. Slide the mode switch to [  ] or [  ].
2. Press the  button.
  - The last image and the quick delete menu appear on the screen.
3. Select [Execute] with the  $\blacktriangle$  /  $\blacktriangledown$  buttons.
4. Press the SET button to confirm the deletion.
  - To not delete, select [Cancel], and press the SET button.



### Erasing a single image / Erasing all images

1. Press the  button.
2. Select the image you want to erase with the  $\blacktriangleleft$  /  $\blacktriangleright$  buttons.
3. Press the  button.
4. Select [Single] or [All] with the  $\blacktriangle$  /  $\blacktriangledown$  buttons, and press the SET button.
  - [Single]: Erases the selected image or the last image.
  - [All]: Erases all of the images except for the protected images.
5. Select [Execute] with the  $\blacktriangle$  /  $\blacktriangledown$  buttons, and press the SET button.
  - To not erase, select [Cancel], and press the SET button.



- Deleting an image will not affect sequential image numbering. For example, if you delete image number 240, the next captured image will be numbered 241 even though 240 no longer exists. In other words, an image-number is removed when an image is deleted and will not be reused or reassigned to another subsequently captured image.

# MENU OPTIONS

## Capture Menu

This menu is for the basic settings to be used when capturing still images.

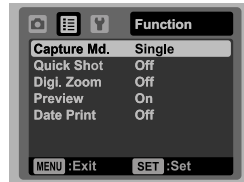
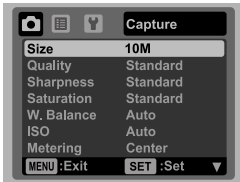

1. Slide the mode switch to [CAM].
2. Press the MENU button, and select the [Capture] / [Function] menu with the ◀ / ▶ buttons.
3. Select the desired option item with the ▲ / ▼ buttons, and press the SET button to enter its respective menu.
4. Select the desired setting with the ▲ / ▼ buttons, and press the SET button.
5. To exit from the menu, press the MENU button.

### Size

This sets the size of the image that will be captured.

- \* [10M] 3648 x 2736
- \* [6M] 2816 x 2112
- \* [4M] 2272 x 1704
- \* [2M] 1600 x 1200
- \* [VGA] 640 x 480

### Quality

This sets the quality (compression) at which the image is captured.

- \* [FINE] Fine
- \* [STD] Standard
- \* [ECON] Economy

### Sharpness

This sets the sharpness of the image that will be captured.

- \* Hard / Standard / Soft







### Saturation

This sets the saturation of the image that will be captured.

- \* High / Standard / Low







### **W. Balance**

This sets the white balance for a variety of lighting conditions and permits images to be captured approaching the conditions that are seen by the human eye.

- \* [Blank] Auto
- \* [  ] Incand.
- \* [  ] Fluoresc. 1
- \* [  ] Fluoresc. 2
- \* [  ] Daylight
- \* [  ] Cloudy
- \* [  ] Manual WB

### **ISO**

This sets the sensitivity for capturing images. When the sensitivity is raised (and the ISO figure is increased), photography will become possible even in dark locations, but the image will appear more pixelated (grainier).

- \* [Blank] Auto
- \* [  ] ISO 64
- \* [  ] ISO 100
- \* [  ] ISO 200
- \* [  ] ISO 400
- \* [  ] ISO 800
- \* [  ] ISO 1600

### **Metering**

This sets the metering method for calculating the exposure.

- \* Center: Averages the light metered from the entire frame, but gives greater weight to the subject matter at the center.
- \* Spot: A very small portion of the center of the screen is measured to calculate the correct exposure.
- \* Average: The exposure is measured over all the image area.







### **Color**

This sets the color of the image that will be captured.

- \* Standard / Vivid / Sepia / B&W / Blue / Red / Green / Yellow / Purple

**Capture Md.**

This sets the recording method at the time of capturing images.

- \* [Blank] Single: Captures one image at a time.
- \* [  ] Continuous: Permits continuous capture of up to 3 images.
- \* [  ] AEB: Permits 3 consecutive images in the order of standard exposure, underexposure and overexposure compensation.
- \* [  ] Album Shot: Creates an album-like layout to combine 3 shots into a single image.
- \* [  ] Burst: Permits continuous photography while pressing and holding the shutter button. As long as you hold the shutter button pressed, images are captured until the memory capacity is exhausted.
- \* [  ] Cont.flash: Permits the continuous capture of up to 3 images with flash.
- \* [  ] Pre-shot: Lets you capture the background first, then have someone capture you in front of it.
- \* [  ] Coupl.shot: Uses separate areas to combine two shots. You can include yourself in the shot.

**Quick Shot**

If this function is set to “On”, the camera takes a quick shot without focusing.

- \* On / Off

**Digi. Zoom**

This sets whether or not to use digital zoom at the time of photography.

- \* On / Off

**Preview**

This sets whether or not to display the captured image on the screen immediately after the image is captured.

- \* On / Off

**Date Print**

The date of recording can be printed directly on the still images. This function must be activated before the image is captured.

- \* On / Off

## Video Menu

This menu is for the basic settings to be used when recording video clips.

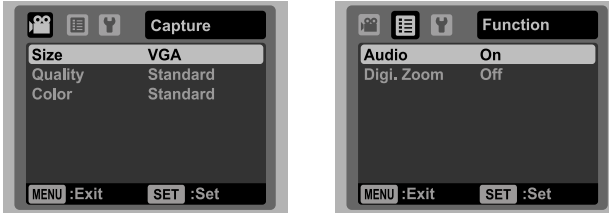

1. Slide the mode switch to [CAM].
2. Press the MENU button, and select the [Capture] / [Function] menu with the ◀ / ▶ buttons.
3. Select the desired option item with the ▲ / ▼ buttons, and press the SET button to enter its respective menu.
4. Select the desired setting with the ▲ / ▼ buttons, and press the SET button.
5. To exit from the menu, press the MENU button.



### Size

This sets the size of the video clip that will be captured.

- \* [ VGA ] 640 x 480
- \* [  VGA ] 320 x 240

### Quality

This sets the quality (compression) at which the video clip is captured.

- \* [  ] Fine
- \* [  ] Standard

### Color

This sets the color of the video clip that will be captured.

- \* Standard / Vivid / Sepia / Monochrome / Blue / Red / Green / Yellow / Purple

### Audio

This sets whether or not to record audio at the time of video recording.

- \* On / Off

### Digi. Zoom

Refer to the section in this manual titled “Digi. Zoom” in Capture Menu for further details.

## Playback Menu

In the [ ] mode, choose which settings are to be used for playback.

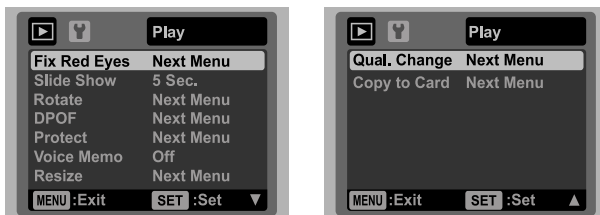

1. Press the [ ] button.
2. Press the MENU button.
3. Select the desired option item with the ▲ / ▼ buttons, and press the SET button to enter its respective menu.
4. Select the desired setting with the ▲ / ▼ buttons, and press the SET button.
5. To exit from the menu, press the MENU button.

### Fix Red Eyes

Refer to the section in this manual titled "Removing Red-eye" for further details.

### Slide Show

This function enables you to play back your still images automatically in order one image at a time.

\* 3 Sec. / 5 Sec. / 10 Sec.

### Rotate

If you wish to rotate a still image 90 degrees to the right, select +90°; if you wish to rotate it 90 degrees to the left, select -90°. Video clips cannot be rotated.

\* +90° / -90°

### DPOF

Refer to the section in this manual titled "DPOF Settings" for further details.

### Protect

Refer to the section in this manual titled "Protecting Images" for further details.

### Voice Memo

Refer to the section in this manual titled "Attaching Voice Memos" for further details.

### Resize

Resizes a previously saved image. Resizing replaces the original image with the changed image. It is only possible to resize to a smaller size.



## ***OPTIMA 1438m***

---

### **Qual. Change**

Changes the quality (compression) of a recorded image. Compresses images down to half their size or less, and overwrites old size images with newly compressed images. It is only possible to reduce the image quality/size, never to increase it.

### **Copy to Card**

Allows you to copy your files from the camera's internal memory to an SD/SDHC memory card. Of course, you can only do this if you have a memory card installed and some files in the internal memory.

\* Cancel / Execute

## Setup Menu

Set your camera's operating environment.



1. Slide the mode switch to [ ] or [ ] or press the button.
2. Press the MENU button, and select the [Setup] menu with the ► button.
3. Select the desired option item with the ▲ / ▼ buttons, and press the SET button to enter its respective menu.
4. Select the desired setting with the ▲ / ▼ buttons, and press the SET button.
5. To exit the menu, press the MENU button.

### Date/Time

Refer to the section in this manual titled “Setting the Date and Time” for further details.

### Language

Refer to the section in this manual titled “Choosing the Language” for further details.

### Auto Off

If no operation is performed for a specific period of time, the power to the camera is automatically turned off. This feature is useful for reducing battery consumption.

\* 1 Min. / 2 Min. / 3 Min. / Off

### Beep

This sets whether or not to mute the camera sound each time you press the camera's buttons.

\* On / Off

### Display

This sets the image information display state.

\* Default / All / Off

### Video Out

This sets your camera to match the system of the equipment that you are going to connect to the camera.

\* PAL / NTSC

**Fr. No. Reset**

This creates a new folder. The captured images are recorded to the newly created folder from number 0001.

\* Cancel / Execute

**Light Freq.**

This camera supports different lighting frequencies: 50 Hz and 60 Hz. When photographing under fluorescent lighting, select the correct frequency setting depending on your local area's voltage. This function is only effective if you set the White Balance to Fluorescent setting.

\* 50 Hz / 60 Hz

**LCD Bright.**

Select a brightness level for the LCD monitor. The LCD becomes brighter with the ▲ button and darker with the ▼ button. The adjustment range is from -5 to 5.

**Format**

Refer to the section in this manual titled "Formatting the Memory Card or Internal Memory" for further details.

**Media Info.**

This displays the free capacity of the internal memory or the memory card.

**Sys. Info.**

This displays the firmware version of the camera.

**Sys. Reset**

This returns all basic settings to the camera's default settings. The time setting will not be reset.

\* Cancel / Execute

## TRANSFERRING FILES TO YOUR COMPUTER

### System Requirement

Windows	Macintosh
<ul style="list-style-type: none"><li>■ Pentium III 1GHz or equivalent</li><li>■ Windows 2000/XP/Vista</li><li>■ 512MB RAM</li><li>■ 150MB available hard disk space</li><li>■ CD-ROM drive</li><li>■ Available USB port</li></ul>	<ul style="list-style-type: none"><li>■ PowerPC G3/G4/G5</li><li>■ OS 9.0 or later</li><li>■ 256MB RAM (512 MB recommended)</li><li>■ 128MB available hard disk space</li><li>■ CD-ROM drive</li><li>■ Available USB port</li></ul>

### Downloading Your Files

1. Connect one end of the USB cable to an available USB port on your computer.
2. Connect the other end of the USB cable to the USB terminal on the camera.
3. Turn on your camera.
4. Select [PC] using the ▲ / ▼ buttons and press the SET button.
5. From the Windows desktop, double click on “My Computer”.
6. Look for a new “removable disk” icon.
  - This “removable disk” is actually the memory (or memory card) in your camera. Typically, the camera will be assigned drive letter “e” or higher.
7. Double click on the removable disk and locate the DCIM folder.
8. Double click on the DCIM folder to open it to find more folders.
  - Your recorded images and video clips will be inside these folders.
9. Copy & Paste or Drag-N-Drop image and video files to a folder on your computer.

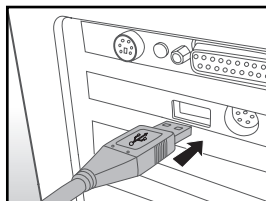

**Mac users:** Double-click the “untitled” or “unlabeled” disk drive icon on your desktop. iPhoto may automatically launch.

## **USING THE CAMERA AS A PC CAMERA**

Your camera can act as a PC camera, which allows you to videoconference with business associates, or have a real-time conversation with friends or family. To use the camera for videoconferencing, your computer system must include the items as below:

- Microphone
  - Sound card
  - Speakers or headphones
  - Network or Internet connection
1. After installing the PC camera driver (included on the CD-ROM) in your Windows operating system, restart your computer.
  2. Connect one end of the USB cable to the USB terminal of the camera.
  3. Connect the other end of the USB cable to an available USB port on your computer.
  4. Turn on your camera.
  5. Select [PC Camera] with the ▲ / ▼ buttons and press the SET button.
  6. Position the camera steadily on top of your computer monitor or use a tripod.
  7. Launch the videoconferencing application software.
    - Simply follow the instructions in the application software to start your camera.



- 
- This function is not supported by Mac.
  - It is recommended that you use Windows Netmeeting (Windows Meeting Space on Windows Vista) as a videoconferencing application software.
  - The video resolution for videoconferencing applications is generally 320 x 240.
  - For more information about the operation of videoconference application software, refer to its respective help documentation.

## EDITING SOFTWARE INSTALLATION

There are 3 types of software included on the CD-ROM:

**ArcSoft MediaImpression™** - manages your media for you, and gives you tons of fun and exciting ways to create and share projects featuring your photo, video, and music files. Create your own movies or photo slide shows, complete with soundtrack; edit, enhance, and add creative fun effects to your photos; and share your files easily through simple email attachments or popular photo printing and video sharing websites.

**Print Creations** - brings you a family of fun and easy print-project software that brings out the creativity in you. You can personalize the designs with your own digital pictures and text based on professionally designed templates and layouts. Projects can be printed at home or saved as image files for sharing with family and friends by email or the web.

**Arcsoft Panorama Maker® 4.0** - Like magic, ArcSoft Panorama Maker® 4 turns any series of overlapping photos into a gorgeous panoramic image in just seconds. The program does most of the work for you by automatically selecting an entire group of pictures with one click, automatically organizing the photos into the proper order, then seamlessly stitching the photos into a panoramic masterpiece that you can print, share or post to the web. Create horizontal, vertical and 360° panorama pictures all within this one amazing program.

To install software:

1. Insert the CD-ROM that came with the camera into your CD-ROM drive.  
The welcome screen appears.
2. Click the respective software name.  
Follow the on-screen instructions to complete the installation.



- 
- For more information about the operation of the software, refer to its respective help documentation.
  - For Windows 2000/XP/Vista users, please make sure you install and use the software in "Administrator" mode.
  - The software is not supported by Mac.

## SPECIFICATIONS

Item	Description
Image sensor	1/2.33" CCD sensor (10.0 megapixels)
Image resolution	Still image 3648 x 2736, 2816 x 2112, 2272 x 1704, 1600 x 1200, 640 x 480 Video clip 640 x 480 (30 fps), 320 x 240 (30 fps)
LCD monitor	3.0" full color TFT LCD (230K pixels)
Recording media	32MB internal memory (27MB available for image storage) Supports SD/SDHC memory card (up to 8GB) (optional)
File format	DCF, JPEG (EXIF 2.2), DPOF, Motion-JPEG (AVI)
Lens	4x optical zoom lens Aperture range: 2.5(W) - 5.6(T) Focal length: 5.8mm - 23.2mm (equivalent to 32mm - 128mm on a 35mm camera)
Focus Range	Standard 0.5m to infinity Macro Wide: 0.05m to infinity Tele: 0.5m to infinity
Shutter speed	2 - 1/2000 sec.
Digital zoom	4x (Capture mode) 4x (Playback mode)
Flash effective range	0.5m - 3.0m (Wide) 0.5m - 1.5m (Tele)
Terminals	AV OUT USB 2.0 compliant (2 in 1 terminal)
Power supply	Rechargeable Lithium-ion battery (3.7V)
Dimensions	Approx. 95 x 57 x 22.7mm (without protruding parts)
Weight	Approx. 130g (without battery and memory card)





\* Design and specifications are subject to change without notice.

## APPENDIX

### Possible Number of Shots

#### Possible number of shots (still image)

The table shows the approximate number of shots that you can capture in each setting based on the capacity of the internal memory and the SD/SDHC memory card.

Size	Quality	Internal Memory	SD/SDHC memory card capacity						
			128MB	256MB	512MB	1GB	2GB	4GB SDHC	8GB SDHC
 3648 x 2736	Fine	5	27	55	112	225	451	903	1812
	Standard	13	59	120	241	484	969	1940	3894
	Economy	15	68	138	278	558	1117	2236	4488
 2816 x 2112	Fine	16	71	143	288	578	1158	2319	4654
	Standard	21	93	187	376	755	1511	3025	6071
	Economy	22	97	195	393	787	1577	3157	6335
 2272 x 1704	Fine	28	124	250	502	1006	2015	4034	8095
	Standard	30	133	268	538	1078	2159	4321	8671
	Economy	35	155	313	629	1260	2524	5051	10136
 1600 x 1200	Fine	53	235	472	949	1901	3805	7615	15281
	Standard	62	271	545	1094	2192	4388	8783	17624
	Economy	67	295	594	1192	2388	4781	9568	19200
VGA 640 x 480	Fine	125	544	1094	2194	4395	8797	17605	35326
	Standard	146	635	1276	2560	5127	10263	20539	41214
	Economy	176	766	1541	3091	6191	12391	24797	49759

#### Possible recording time / sec (video clip)

Size	Quality	Internal Memory	SD/SDHC memory card capacity						
			128MB	256MB	512MB	1GB	2GB	4GB SDHC	8GB SDHC
VGA 640 x 480	Fine	00:31	02:15	04:32	09:07	18:15	36:32	59:59	59:59
	Standard	00:45	03:16	06:35	13:13	26:29	53:01	59:59	59:59
 320 x 240	Fine	01:43	07:31	15:06	30:18	59:59	59:59	59:59	59:59
	Standard	02:19	10:08	20:22	40:52	59:59	59:59	59:59	59:59

\* We recommend a memory card of at least 10MB/Sec write speed to prevent auto stop or unexpected results. If you experience an error using a slower SD/SDHC memory card, you can set your camera's video recording to QVGA (320 x 240) and standard quality.



## Troubleshooting

Refer to the symptoms and solutions listed below before sending the camera for repairs. If the problem persists, contact your local reseller or service center.

Symptom	Cause	Solutions / Corrective Actions
The power does not come on.	The battery is not inserted.	Insert the battery correctly.
	The battery is exhausted.	Recharge the battery.
The battery runs out quickly.	The battery is not fully charged. The battery has not been used for an extended period of time after being charged.	Fully charge the battery and discharge it for at least one complete cycle before use to maximize its performance and lifetime.
The battery or camera feels warm.	Long period of continuous use of the camera or the flash.	
Even if I press the shutter button, the camera does not take a picture.	The shutter button is not pressed all the way down.	Press the shutter button all the way down.
	The memory card does not have any free capacity.	Insert a new memory card, or delete unwanted files.
	The memory card is write-protected.	Remove the write-protection.
Images do not appear on the LCD monitor.	LCD monitor is dark.	Adjust the brightness of the LCD monitor in the menu.
Although it is set to auto focus, it does not focus.	The lens is dirty.	Wipe clean with a soft, dry cloth or lens paper.
	The distance to the subject is smaller than the effective range.	Move your subject to within the effective focus range.
The contents on the memory card cannot be played back.	You played back a memory card that was not formatted by this camera.	Insert a memory card that was formatted on this camera.
Files cannot be deleted.	The file is protected.	Cancel protection.
	The memory card is write-protected.	Remove the write-protection.
Even when the camera buttons are pressed, it does not operate.	The battery is running low.	Recharge the battery.
The date and time are wrong.	The correct date and time is not set.	Set the correct date and time.
Cannot download images.	The free space on the hard disk in your computer may be insufficient.	Check whether the hard disk has space for running Windows, and if the drive for loading image files has a capacity at least that of the memory card inserted in the camera.
	No power supply.	Recharge the battery.

## Connecting to a PictBridge Compliant Printer

Read this section if the model you purchased is included with the PictBridge functions.

If a printer that supports PictBridge is available, images can be printed by connecting the digital still camera directly to the PictBridge-compatible printer without using a computer.

### Connecting the camera to the printer

1. Connect one end of the USB cable to your camera.
2. Connect the other end of the USB cable to the USB port on the printer.
3. Turn on your camera.
4. The [USB] screen is displayed. Select [PictBridge] with the ▲ / ▼ buttons, and press the SET button.

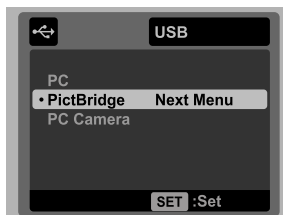

### Printing images

When the camera is properly connected to a PictBridge compliant printer, the PictBridge menu is displayed on the monitor.

1. Select the item you want to configure with the ▲ / ▼ buttons, and press the SET button.
  - [Images]: Select whether you want to print specific image or all images. You may also select the printing number for a specific image.
  - [Date Print]: According to the printer type, select whether you want to print the image with date imprint or not.
  - [Paper Size]: Select the desired paper size according to the printer type.
  - [Layout]: Select the desired printing layout according to the printer type.
  - [Print]: After all settings are configured, select this item to start printing.
2. If you select [Images] in the previous step, the figure shown on the right-hand side will appear. Select [Single], [All] or [DPOF] with the ▲ / ▼ buttons, and press the SET button.
  - [Single]: Select to print one specific image.
  - [All]: Select to print all images.
  - [DPOF]: Select to print images with DPOF settings.
  - [Exit]: Exit Images option.

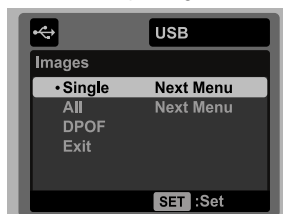
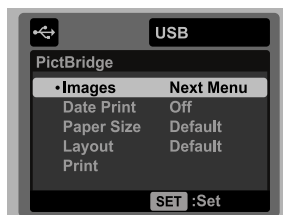

## OPTIMA 1438m

- If you select [Single] in the previous step, the figure shown on the right hand side will appear.
  - Select the image that you want to print with the ◀ / ▶ buttons.
  - Select the [Print Num.] (up to 99) with the ▲ / ▼ buttons.
  - After selecting the desired image and printing number, press the SET button to confirm.
- Select [Exit] with the ▲ / ▼ buttons, and press the SET button.

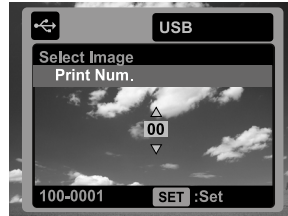

- Select [Print] with the ▲ / ▼ buttons, and press the SET button to start printing.

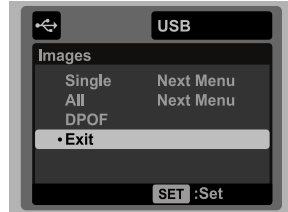

- The printing starts and the figure shown on the right-hand side appears.

- [COMPLETE] will be displayed temporarily, reminding you that the printing procedure is finished.
- If an error is detected during the connection (i.e. a printer hardware problem) between camera and printer, [PRINT ERROR] will be displayed.
- If an error is detected during the communication (i.e. wrong setting on the camera) between camera and printer, [ERROR] will be displayed.

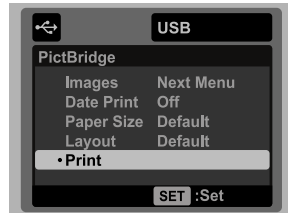

- Image printing may fail if power to the camera is cut off.

## **Customer care**

More information on the complete AgfaPhoto digital camera product range can be found at [www.plawa.com](http://www.plawa.com) and [www.plawausa.com](http://www.plawausa.com).

**Service & Repair (USA/ Canada):**

1-866 475 2605

[www.plawausa.com](http://www.plawausa.com)

**Support Service (USA/ Canada)**

[support-apdc@plawausa.com](mailto:support-apdc@plawausa.com)

**Service & Repair Hotline (EU):**

00800 752 921 00 (from a landline only)

**Service & Support Hotline (Germany):**

0900 1000 042 (1.49 euros/min. from a German landline only)

**Online Service / International contact:**

[support-apdc@plawa.com](mailto:support-apdc@plawa.com)

**Manufactured by**

plawa-feinwerktechnik GmbH & Co. KG

Bleichereistraße 18

73066 Uhingen

Germany

AgfaPhoto is used under license of Agfa-Gevaert NV & Co. KG. Agfa-Gevaert NV & Co. KG. does not manufacture this product or provide any product warranty or support. For service, support and warranty information, contact the distributor or manufacturer. Contact: AgfaPhoto Holding GmbH, [www.agfaphoto.com](http://www.agfaphoto.com)